

# LIGHTING

Day or night, lights are a sign of activity and life in homes, offices, shopping malls and more. Adding lights can make a big difference on a layout by adding interest and realism.

For years, the only way to add lights to a layout was with electrical knowledge, complicated wiring and expensive tools. Not everyone is an electrician or has time to learn these skills. The Just Plug® Lighting System ensures anyone can add lights to their layout as quickly and easily as plugging something in.

Just Plug provides a complete, simple way to add realistic LED lighting. This system works with new and existing layouts or projects. The modular design works for all scenes and allows easy, customizable expansion. It is easy to combine and add Pre-Lit Features like Vehicles, Street Lights, Wall Mount Lights or Just Plug-equipped Built-&-Ready buildings. Get started by plugging a Pre-Lit Feature, such as a Built-&-Ready building, into a Light Hub. It truly is as easy as Just Plug and you're done!





# GETTING STARTED WITH JUST PLUG ONLINE VIDEO

To get started, you need the very basic and core elements of the Just Plug Lighting System: a Light Hub, Power Supply and a Pre-Lit Feature of your choice.

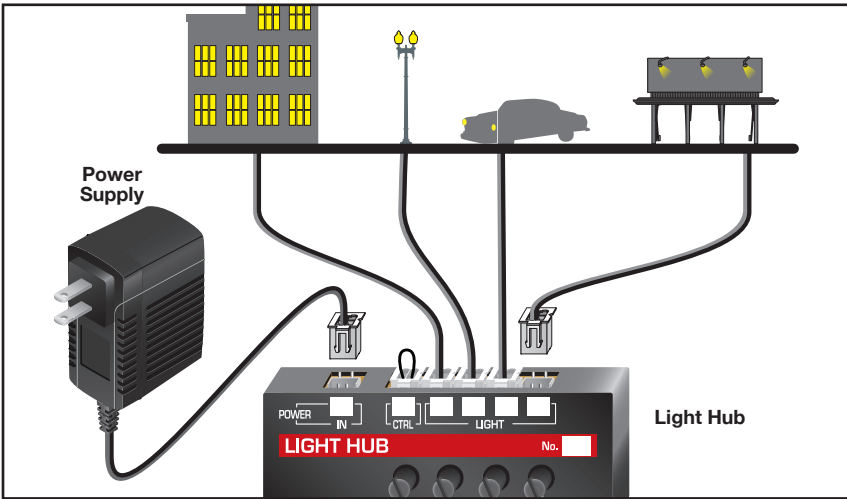

## Product Overview

### Light Hub

Use a Light Hub to deliver power to Just Plug lights quickly and easily. The Light Hub is fully compatible with everything from individual LED lights to Pre-Lit Built-&-Ready buildings. Simply plug lights into the four LIGHT Ports on the Light Hub and regulate brightness with individual dimmer controls.



### Power Supply

The Power Supply transformer connects to the Light Hub, Sequencing Light Hub or Expansion Hub and powers up to 50 Light Hub Ports or 1,000 milliamps (mA). The Power Supply is available for different regions: U.S., U.K., Europe and Australia/New Zealand.



## INSTALLING PRE-LIT FEATURES

All Pre-Lit Features are easy to install on a layout. Once you decide where the feature will be, drill a hole in the layout for the wires and feed the wires through the hole. Choose a location that will be hidden from view or easy to hide later. Then simply plug the wire into the Light Hub and connect the Power Supply to the Light Hub. Once the lights are on, you can adjust the brightness by rotating the dimmer controls. Add up to four Pre-Lit Features to the Light Hub.

### Product Overview

#### Pre-Lit Built-&-Ready Buildings

Pre-Lit Built-&-Ready Buildings include preinstalled LED lighting. These lights include everything from a simple porch light to a flashing light that acts as an air traffic warning light, an interior light for illuminating the whole building, or multiple lights for a single structure.



#### Street and Wall Mount Lights

Bring any scene to life with LED Street and Wall Mount Lights. Light up city streets, rural roads, sidewalks, parking lots and train yards. These lights can be added to any building, billboard, sign, entryway, home or office.



#### Billboards

Just Plug Billboards are an easy way to add life and flair to any scene by advertising local shops and destinations. They are a staple of every town and are often found along highways, buildings and rooftops. Each one includes preinstalled LED lighting to highlight the unique designs and add interest to your layout.



#### Just Plug Vehicles

Whether you're modeling a backcountry drive or a busy downtown scene, these Vehicles instantly add light and interest to any layout. Each vehicle includes a driver and LED headlights and taillights. The taillights are slightly dimmer to simulate a car driving down the street.



#### Just Plug Flags

US Flags are available in Pole or Wall Mount versions. Each one is available in three sizes and works for multiple scales. All Flags, as well as the Medium Union Jack Flag Pole, include a Just Plug Spotlight to highlight the Flag.



#### LED Landscape Lights

Just Plug LED Landscape Lights shed some light on important features and simply plug into a Light Hub or Sequencing Light Hub. Landscape Lights include Spotlights and Floodlights. Use Spotlights to cast a narrow beam of light to highlight building columns, signs, flags or monuments. Choose Floodlights to cast a broad beam of light for illuminating buildings, landmarks and other large areas. Just Plug LED Landscape Lights include two lights per package.

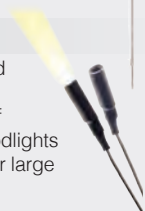



## EXPANDING WITH JUST PLUG ONLINE VIDEO

Once your Light Hub is full, you will need to expand your system if you want more lights. The Just Plug Lighting System makes it easy to expand lighting on your layout.

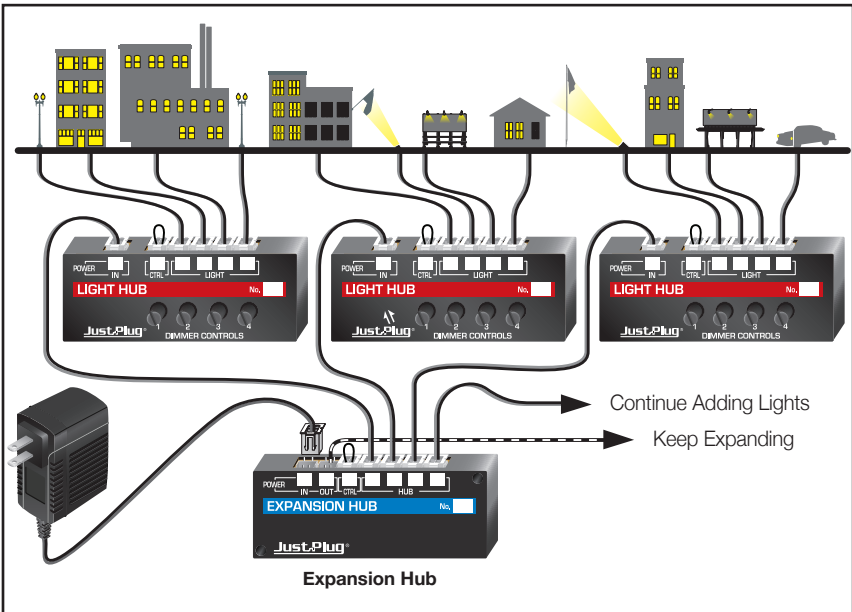

## Product Overview

### Expansion Hub

Use the Expansion Hub to extend power to 4 Light Hubs or Sequencing Light Hubs, expanding your Just Plug Lighting System quickly and easily. The Expansion Hub includes four Connecting Cables for connecting hubs.



## INSTALLING EXPANSION HUBS

To begin expanding, disconnect the Power Supply from the Light Hub. Plug the Power Supply into the Expansion Hub. Then, connect the Expansion Hub to the Light Hub using one of the Connecting Cables included in the Expansion Hub package. As soon as the Power Supply is plugged into electricity, the lights will turn on.

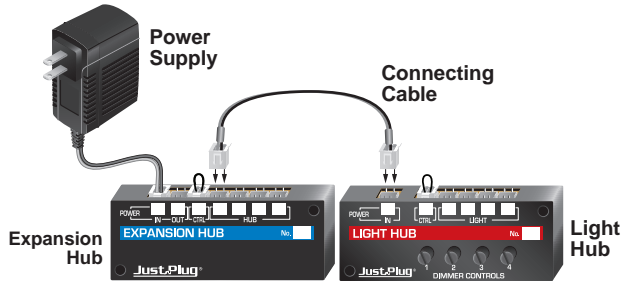

Each Expansion Hub can power up to four Light Hubs. Once your first Expansion Hub is full, you can continue to grow the system by linking Expansion Hubs together, as shown.

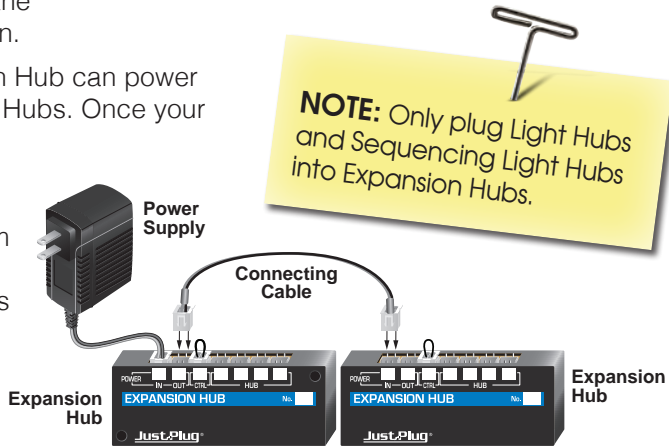

## USING ACCESSORIES

As you expand and enhance your layout with Just Plug features, you may find the need to switch the system or quickly extend the length of your wires. You may also want to create the illusion of occupancy by adding a random effect of lights turning on and off, like they do in a real city. As you expand in the modeling hobby, the need to light dioramas on location in places without power could arise. Just Plug Accessories allow you to do all of these things, simply and easily.



## Product Overview

### Auxiliary Switch

Use the Auxiliary Switch to control lights with the flick of a switch. The Auxiliary Switch plugs into Light Hubs, Sequencing Light Hubs and Expansion Hubs. Use the rocker-style on/off switch to easily turn the power on or off.



### Sequencing Light Hub

Bring your layout to life with a Sequencing Light Hub. Add lights to the four LIGHT Ports that individually sequence on and off. Use the dimmer controls to regulate individual brightness, and use the speed control to adjust the sequence speed. Turn sequencing off to use it as a Light Hub.



### Port Sharing Device

The Port Sharing Device is an easy and economical way to expand the Just Plug Lighting System. Use the Port Sharing Device with a Light Hub or Sequencing Light Hub to power up to four Stick-On or Nano LED Lights per LIGHT Port.



### Connecting Cables

Connecting Cables are easy-to-install cable plugs that make connections a snap. Connect any hub to an Expansion Hub.

An Expansion Hub is a device that allows one Power Supply to power multiple Light Hubs. Expansion Hubs make it very easy and quick to expand the number of lit features on your layout.



### Extension Cables

Use Extension Cables to extend the length of any Just Plug cable. Extension Cables work with the Just Plug Power Supply, Pre-Lit Built-&-Ready Buildings equipped with a Just Plug cable, LED Stick-On Lights, LED Nano Lights, Linker Plugs, Connecting Cables and additional Extension Cables.



### Battery Case

The Battery Case provides power and portability to the Just Plug Lighting System. Use the Battery Case as an alternative to the Just Plug Power Supply to power Light Hubs, Sequencing Light Hubs and Expansion Hubs. The Battery Case requires two 9-volt batteries.



### Tidy Wire Kit

The Tidy Wire Kit gives you easy access for expansion while keeping cables secure and tidy. Attach the Cable Tie Mounts to your layout with their adhesive-backing and secure cables with Cable Ties to keep them clear of your layout. Use the Cable Tie Labels to identify connections.



## ENHANCE REALISM

In a real city, if you watch a large building at night you will notice that the lights in individual rooms blink on and off as people move throughout a structure. The Sequencing Light Hub makes it simple to mimic this effect and increase realism of your layout. A Sequencing Light Hub works just like a Light Hub except it has an additional sequencing feature that turns lights on and off in a sequence that appears random. The speed of the sequence can also be adjusted to tweak the effect on the layout.

Swap out a Light Hub for a Sequencing Light Hub and initiate the sequence by flipping the sequencing switch on. Then rotate the speed dial to increase or decrease the sequence of lights turning on and off.

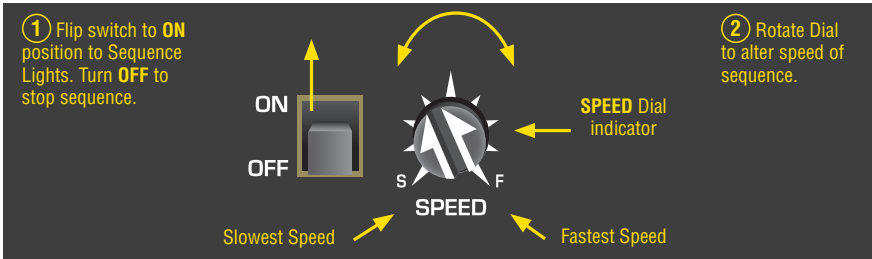

Light individual rooms in apartment buildings, homes or offices with the Sequencing Light Hub. Block some windows in the building so that some rooms always remain dark while in others the lights turn on and off. For the most realistic results, try spreading the lights throughout buildings and the layout. The sequencing effect is best achieved when the Sequencing Light Hub is used with other Light Hubs. The lights connected to Light Hubs will remain on continuously while those connected to the Sequencing Light Hubs blink off.

However, we do not recommend using the Sequencing Light Hub for Pre-Lit Features like Street Lights, Billboards or Flags. These lights remain fixed in real life and typically remain lit all night.

## BATTERY POWER

If your location has no access to wall outlets, you can still power your Just Plug lights. The Battery Case is powered by two 9V Batteries and plugs into Hubs just like the Power Supply. Every lighting configuration is different and will affect how long the batteries last. About 30 lights can be powered for approximately 5-6 hours with the Battery Case.



## SWITCHING THE JUST PLUG SYSTEM ONLINE VIDEO

As you expand, you may want to consider adding an Auxiliary Switch so that you don't have to crawl under benchwork to reach the Power Supply transformer. Adding an Auxiliary Switch is simple. Plug the Auxiliary Switch into a Light Hub, Sequencing Light Hub or Expansion Hub's CTRL Port. Then, any light connected to the Hub will turn on and off with the flip of the Auxiliary Switch.

**NOTE:** The CTRL port can only be used to connect an Auxiliary Switch, or DCC, to a Hub. The CTRL port cannot power LEDs or Hubs.

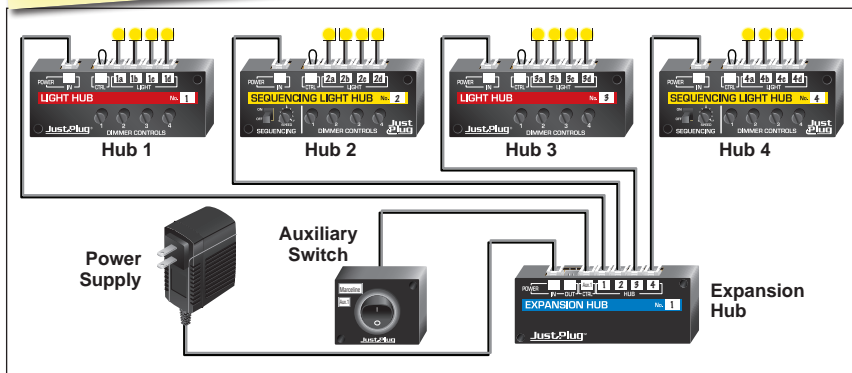
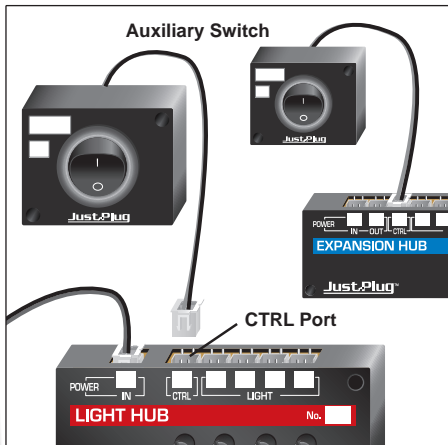





# CUSTOMIZE

Easily adapt Just Plug to extend wire length, drill smaller holes, create custom wire connections, light unlit features, or eliminate building glow.

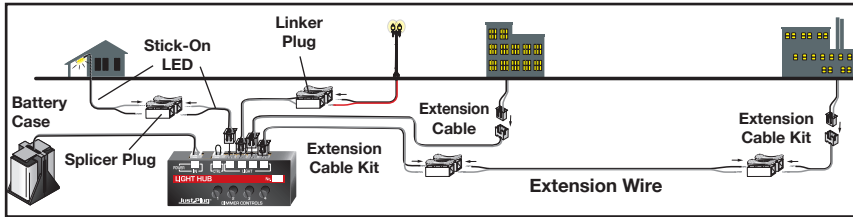

## Product Overview

### Lights & Hub Set

Use the Auxiliary Switch to control lights with the flick of a switch. The Auxiliary Switch plugs into Light Hubs, Sequencing Light Hubs and Expansion Hubs. Use the rocker-style on/off switch to easily turn the power on or off.



### Stick-On and Nano LED Lights

Stick-On and Nano Lights are available in a variety of colors and can be added anywhere you need lights, such as a building or vehicle. Stick-On Lights are adhesive-backed for easy installation and come in 7 colors. Nano Lights are small, bright lights that are available in 7 colors and 2 flashing options. Stick-On and Nano LED Lights simply plug into a Light Hub, Sequencing Light Hub or Port Sharing Device.



#### STICK-ON

Adhesive-backed for easy installation

- Orange
- Green
- Blue
- Red
- Warm White
- Cool White
- Yellow



#### NANO

Small in size, big in brightness

- Warm White
- Yellow
- Red
- Green
- Blue
- Cool White
- Orange
- Yellow Flashing
- Red Flashing



## Light Diffusion Window Film

This product diffuses light evenly throughout when lights are on and eliminates the need for a building interior. It blocks the outside view through the windows of an empty building, while still allowing light to shine through the windows from the inside. Use the optional Window Tint together with Diffusing Film to make windows appear dark when lights are off. The Tint and Film material is easy to apply, and each will cover approximately 216 in<sup>2</sup> of window space.

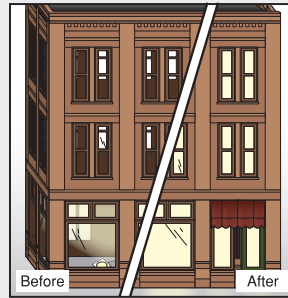

## Light Block Kit

Keep light inside a structure, where it belongs! Seal all light leaks easily by pressing Ribbon Putty into interior corners and joints. Affix it along the bottom edges of structures to secure building to layout surface and block light from bleeding along foundations. Apply Masking Paint to keep light from glowing through walls and shining through windows. Putty will cover 96 linear inches and Paint will cover 1,200 in<sup>2</sup>.



## Splicer Plugs

Splicer Plugs make it easy to properly connect stripped wires. Use Splicer Plugs to quickly reconnect wires after installing LEDs into discreet, small holes.



## Linker Plugs

Linker Plugs are ready to plug into a port on a Light Hub or Sequencing Light Hub. Use them to plug in remotely located Street and Wall Mount Lights.

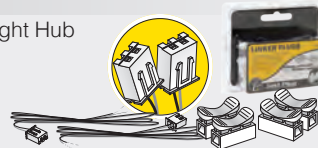

## Extension Wire and Extension Cable Kit

Extension Wire is Just Plug-compatible and has soft insulation for easy stripping. Paired wire is color-coded for proper connection with Splicer Plugs and the Extension Cable Kit.

Use the Extension Cable Kit with Extension Wire to create custom lengths of Just Plug Cables. This allows you to reach Hubs anywhere on your layout or project.

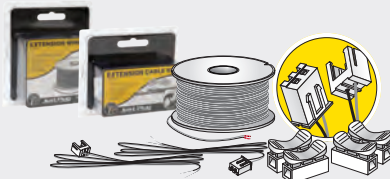

## EXTENDING JUST PLUG CABLES

Some layouts can be very large and may have unique situations where the usual methods of expansion are not enough. You may have one Street Light that is too far away to reach the included Linker Plug, or there may be one lone house on the outskirts of town. You can extend the length of the cables to easily reach your Light Hubs.

### Using Linker Plugs

Connect a lit feature's pigtail wires to the Linker Plug. Then plug the Linker Plug into a Light Hub or Sequencing Light Hub.

### Using Splicer Plugs

Using a Splicer Plug allows you to drill smaller holes in your modeling material. This is because the drill hole only has to be the size of the wire, not the size of a plug. Use Splicer Plugs to connect pairs of pigtail wires from buildings, Extension Wire, Street Lights, Wall Mount Lights, Flags, etc. To use, press the tabs on the top of the Splicer Plug and insert the bare wire into the Splicer Plug and repeat on opposite end, matching positive and negative wires on each side.

### Using the Extension Wire and Extension Cable Kit

Extension Wire is a roll of Just Plug wiring that can be cut to any length you desire. Extension Cable Kits come with both male and female pigtail wires and Splicer Plugs, which means you can extend the length of any wire. When the Extension Cable Kit is used with Extension Wire, you can create any length of Just Plug cable.

### Using Tidy Wire Kit

Use the Tidy Wire Kit to bundle wires together and then secure to the underside of the base with the included adhesive backing. After running the wires, create a diagram showing where the wires are located. Refer to the diagram before doing future modifications that require cutting into the layout.



## LIGHTING EXISTING FEATURES

Pre-lit Features come equipped with lighting, but many features are not built with lighting. You can light unlit structures and features with Stick-On and Nano LEDs. Stick-On and Nano LEDs can be used to light any project for unique effects. These LEDs come in a variety of colors that can be used to make any model or art project shine. Use them to create a phosphorescent look in water features, to make lava flows glow or use them in free-standing sculptures to highlight specific features.

Follow the below techniques to permanently install Stick-On and Nano LEDs in unlit features and structures.

### Choosing a Color

Warm White LEDs represent incandescent light, which is a warm yellowish color light. Incandescent light is the kind of lighting that was very common in the mid-twentieth century in private homes. Cool White LEDs are closer to the color of daylight. They should be used where fluorescent lighting would be installed like in hospitals, schools, businesses or in other areas that must be brightly lit.

Use colored LEDs to add lighting accents. Red LEDs are often used as safety lights on buildings, but can also be installed in vehicles as taillights. Yellow and Orange LEDs can be used to simulate old gas and oil lamps that were powered by various gasses or oils. Gas and oil powered lights produce a very yellow-orange light. Green and Blue LEDs can be used in industries for different kinds of signals. Add Flashing Yellow or Red LEDs to buildings, docks, ships, bridges, etc.

When Warm White and Cool White LEDs are used with tinted materials, like tinted Deep Pour Water, the color will be the color of the material covering the LED. When using a colored LED to light clear materials, the clear material will assume the LED's color. However, if you use a colored LED to light a colored material, the color of light will change and the brightness may be affected.



## Where to Install, Nanos vs Stick-Ons

When choosing LEDs, it is important to consider the brightness of the light. Each structure will be different and require different lighting configurations for different effects.

Stick-On LEDs are brighter than Nanos. Too bright of light is not typically a problem, because you can control the brightness of the light with the Dimmer Controls on the Hub. If unsure of the amount of light needed, try a Stick-On and dim as needed.

In general, large buildings and features tend to need more light to achieve a realistic look. Small buildings and features may be overpowered by too bright of a light. As O Scale structures are large, you will likely need more Stick-On LEDs than Nanos to achieve the desired effect. HO Scale can get good results from either Stick-Ons or Nanos, depending upon the size of the area that needs to be lit. As N Scale structures are very small, Nanos are usually a better option.

Both Stick-On and Nano LEDs are directional lights, which means they must be aimed to illuminate an area. You can use two Stick On or Nano LEDs placed back to back if a 360-degree light is desired. Nano LEDs are very small, and are ideal to install in tight areas and can also be used as drop-down ceiling lights.





## Check for Light Bleed ONLINE VIDEO

The first two steps in installing an LED are establishing the location of the LED and testing for light bleed. Light bleed is when light leaks from the object in areas that should not be lit.

Start by determining where you want to install the LED. Turn the lights in the room off, and test the LED in a few different positions within the object. Use some tape to temporarily adhere the LED while you assess the positioning. When you find the right positioning, make a mark where the LED should be permanently installed.

Once the LED is positioned how you like it, check for light bleed. Light bleed can be seen when the object is in a dark room and the LED is turned on. If light is escaping where you do not want it to escape, you will need to seal or paint that area to stop the bleed before permanently installing the LED.

Fixing light bleed is easy with the Light Block Kit. Use the Masking Paint in the Light Block Kit to paint the interior walls a flat black. This will stop wall glow and may stop light bleed from wall joints. After you have painted the interior walls, test for light bleed. If there is still

wall glow, add another coat of Masking Paint. If light is bleeding only from the wall joints, use the Black Ribbon Putty. Stretch the Black Ribbon Putty over the wall joint and press it into the wall joint. Keep testing and making adjustments until the light bleed is eliminated. Also use the Ribbon Putty to block light from escaping the bottom of the building (page 224).

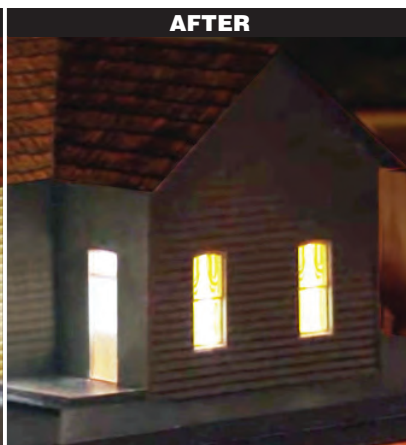
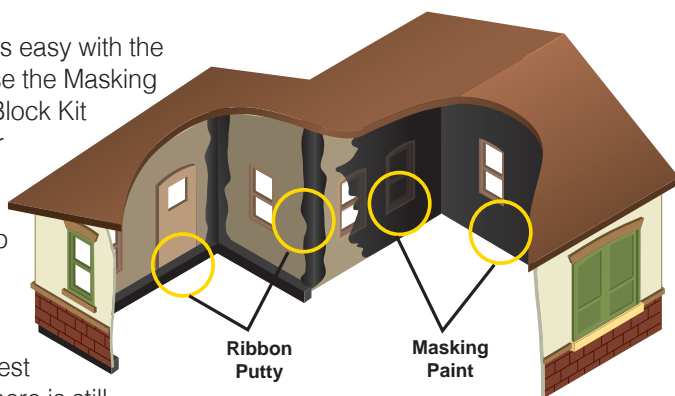

For unique art and craft projects, you may or may not be able to use the Light Block Kit to stop the light bleed. If the black Masking Paint and Ribbon Putty do not seem to be a good fit for your project, use the same materials that you used to construct the object to block the light bleed. Fill the gaps, test for light bleed and repeat as needed.

## Permanently Install the LED

Once light bleed has been addressed, you can permanently install the LED.

Permanently install a Stick-On LEDs by peeling the backing paper from the LED and press in place on the positioning mark you made inside the object. To permanently install a Nano, use cyanoacrylate adhesive (super glue), masking tape or double-sided sticky tape to secure the LED in place.

Once the LED is permanently installed and the glue is dry, run the wiring down a corner of the object that will not be visible to a viewer. If desired, paint the wiring with acrylic paint so that it is inconspicuous and blends into the surface it is against. If lighting a building with an interior, run the wiring down the back of the interior cardstock so it is not visible. Use a little tape or glue to secure the wire. Then, drill a hole, insert the LED wire in the hole and connect to a Light Hub.

## Drilling Smaller Holes

When using Stick-On and Nano LEDs, say under an awning on a building, you will need to drill through the building to feed the LED's plug through it. A hole the size of a plug would likely be visible on any building. However, you can use Splicer Plugs to drill smaller, inconspicuous holes. Clip the plug off of the Stick-On or Nano LED about 3"-5" above the plug. The 3"-5" piece with the plug is called a pigtail. Don't throw the pigtail away. Run the LED's wiring through the small hole drilled in your building. Strip the wire insulation from the pigtail and the LED's wire. Connect both the pigtail and the LED wire to a Splicer Plug. Then, insert the pigtail's plug into a Light Hub or Sequencing Light Hub.



## Adding LEDs with Port Sharing Devices

When using Stick-On and Nano LEDs, you can expand the number of LEDs that a Light Hub powers. Plug a Port Sharing Device into either a Sequencing Light Hub or a Light Hub light port. Then, plug your Stick-On or Nano LEDs into the Port Sharing Device. This is a quick and easy way to expand the number of Stick-On and Nano LEDs on your layout.

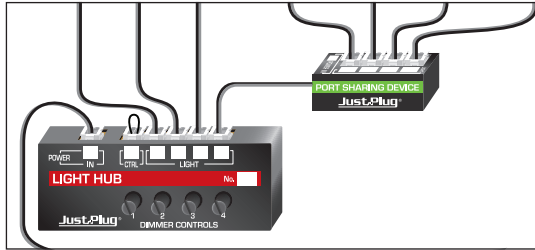

## Light Diffusing Window Film for Buildings ONLINE VIDEO

If you are lighting a structure, it is likely that the structure doesn't have an interior. Viewers looking into the windows of the structure will be able to see the unpainted and unfurnished interior. You can fix this by using the Light Diffusing Window Film kit.

The Diffusing Film blocks the outside view through the windows of an empty building while allowing light to shine through the windows from the inside. When used with the Window Tint (included in the package), the windows will appear dark when the lights are off.

To install, cut the Diffusing Film slightly larger than the window. Apply the included Micro Sticky Spots to the corners of the Diffusing Film and press in place on the building.

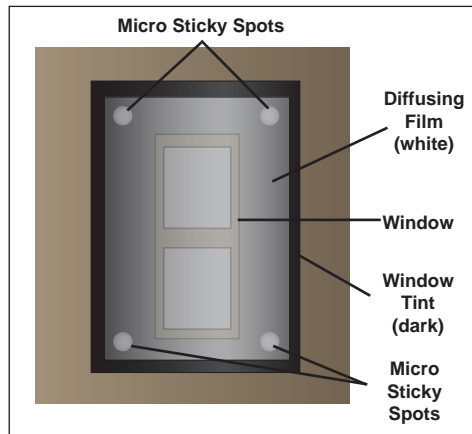

## LEDs in Deep Pour Water

Lava is molten rock that is so hot, it glows. If you are modeling a volcanic area like Hawaii or Iceland, you may want to include glowing pools of Deep Pour Water that is lit with a red or orange LED. There are also occasions where water will glow. Phosphorescence or bioluminescence (glowing water) is a natural phenomenon that occurs in bodies of water where certain kinds of algae and aquatic life exist. Water in pools and fountains also tend to glow since pools and fountains often have lights lining the walls.

Modelers can achieve these looks by submerging Stick-On and Nano LEDs directly in Deep Pour Water. Please note that we only recommend these techniques with Deep Pour Water. Be sure to test the LED for functionality before permanently installing it in Deep Pour Water.

Install the LED directly in the base of the water feature. Install the LED after applying plaster to the terrain contours and before the Water Undercoat is applied. Let the plaster base dry thoroughly before installation. **(1)** Drill a hole and run the LED wire through the hole. Secure the LED and place piece of masking tape over the LED to protect it. **(2/3)** Then, seal the hole in the terrain shell with the plaster product used for the water base.

**(4)** Paint the water base with Undercoat as described in the Water section in Chapter 3. Paint any exposed wire, or glue, with Water Undercoat and let it dry. For the most realism, cover the hole and wiring with underwater landscaping, like rocks. Keep the LED masked off so that the Water Undercoat does not cover up the light. Remove the masking tape after the Water Undercoat has dried. Then, pour Deep Pour Water over the water feature.

