

401 DRYWELL INKS INSTRUCTIONS

Follow these step-by-step instructions to construct the Drywell Inks building. Refer to Walls 1-6 and to the Front and Back Views illustrated below to determine the proper location for each building part. The building parts included in this kit are identified on the left.

Match letters on the drawings below to determine where walls join. For example: [Wall 1, edge A] and [Wall 6, edge A] join each other as an "outside" corner (see Front and Back Views). [Wall 2, edge C] and [Wall 3, edge C] join each other as an "inside" corner.

You will have some entry doors, windows, street level and one-story pilasters, cornices, dock wall, parapet trim and roof left over when your building is completed.

Look through the enclosed catalog to see the complete line of DPM HO scale buildings, as well as the wall sections that are interchangeable with or can be added to this building.

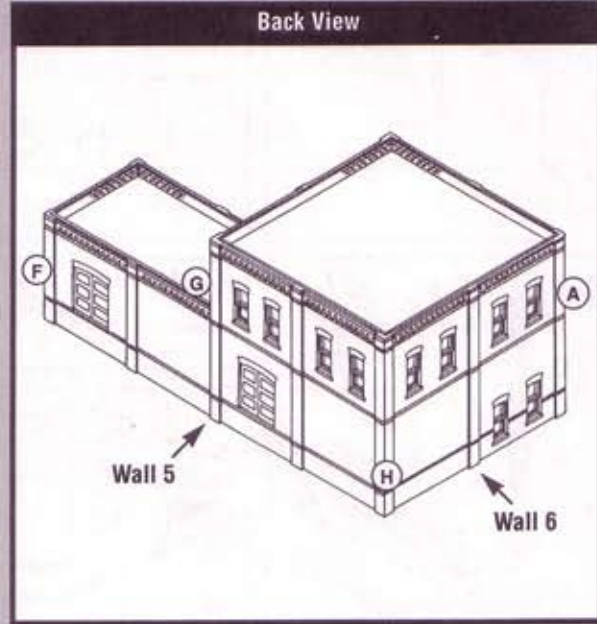
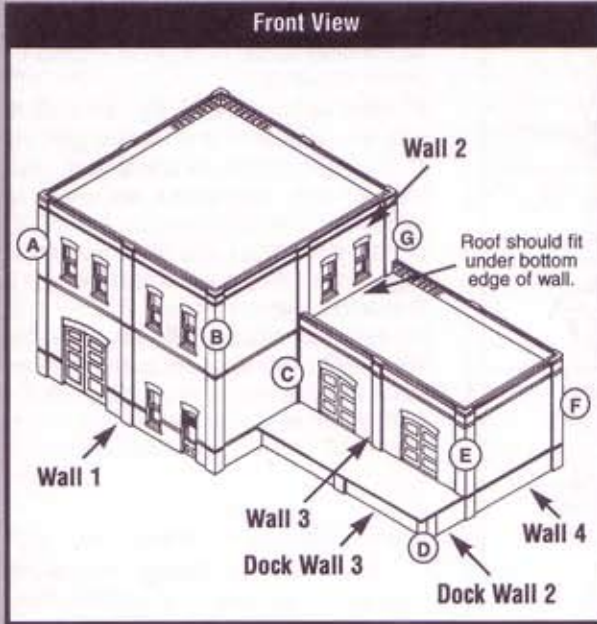
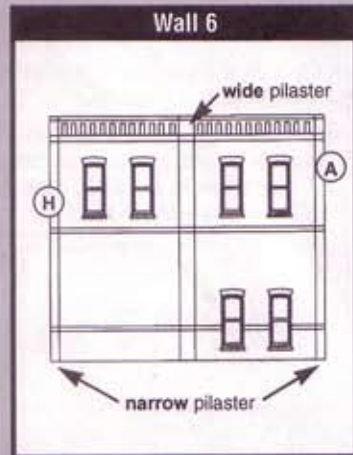
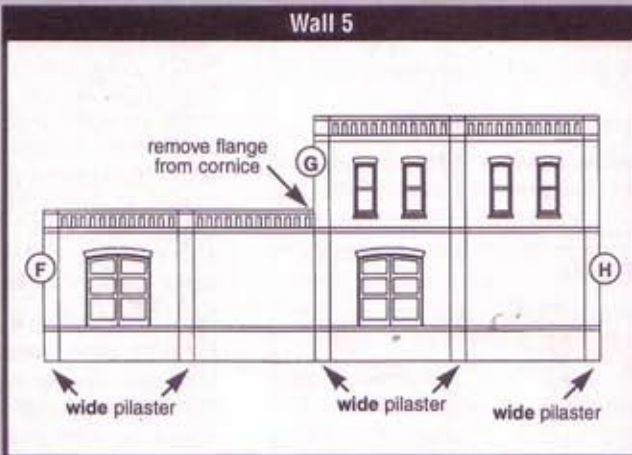
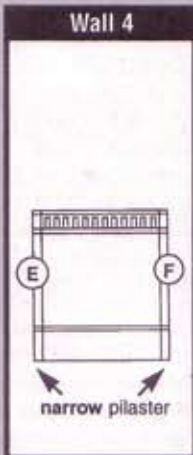
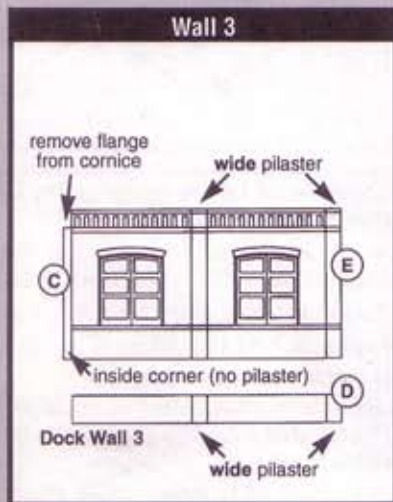
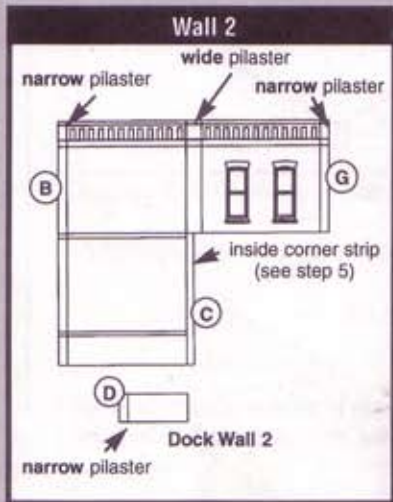
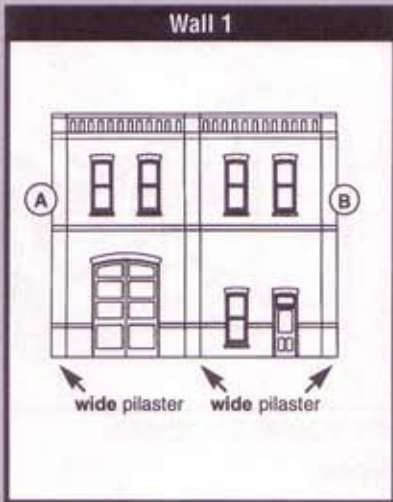
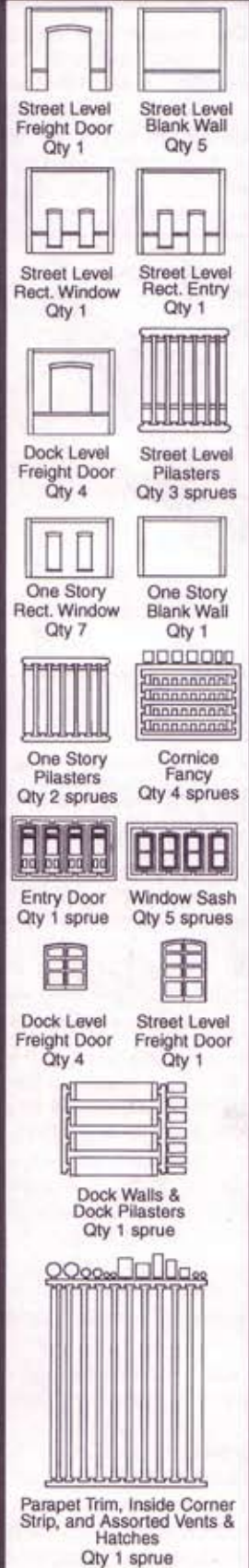

- Additional Material**
- Roof material (1 sheet 6" x 81 1/16")
 - Dock floor (1 sheet 6" x 1 1/2")
 - Clear window material (1 sheet 5" x 5")
 - Black paper (1 sheet 4 1/2" x 7 3/4")
- See reverse side for Details listing.

1 Clean and prepare parts.

Use a hobby knife (i.e., X-Acto) and/or diagonal cutters (i.e., Fiskars) to remove excess plastic created by molding process (Fig. 1).

Don't sand any edges on parts at this time. (Later, in Step 6 you will sand tops and bottoms of assembled panels.)

Do not cut into detail or alter edges of parts.

Fig. 1

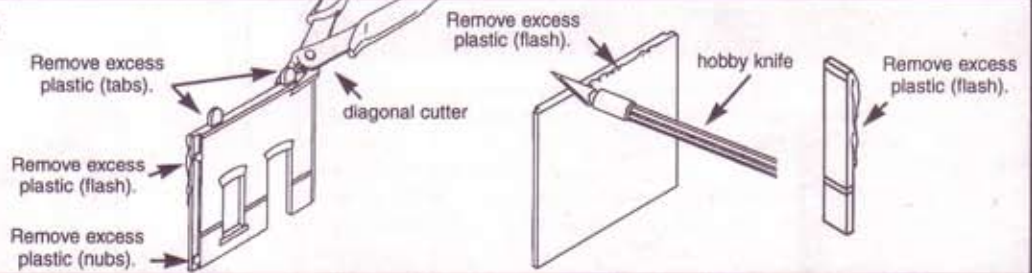

2 Identify the wall sections and pilasters needed to build each wall (see Walls 1-6) and place them in separate groups.

In Steps 3-5, wall sections will be joined together side-by-side with pilasters to form wall panels (Fig. 2).

In Step 7, wall panels will be vertically joined to form an entire wall (Fig. 2).

Follow Steps 3-8 to build one wall at a time beginning with Wall 1. When Wall 1 is complete, repeat Steps 3-8 to build the rest of the walls, one at a time.

Fig. 2

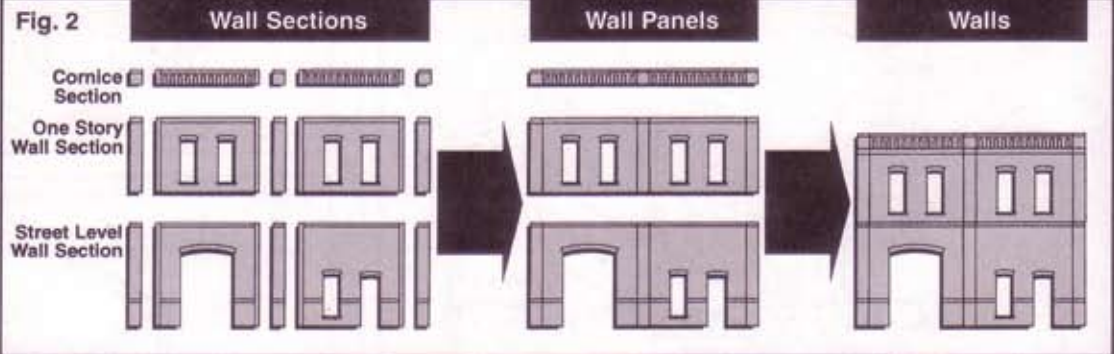

3 Using wide pilasters as joiners, glue wall sections together to form wall panels (Fig. 3A).

Glue with plastic cement or solvent.

Use a straightedge to align sections at their tops (Fig. 3B) one floor at a time.

See Fig. 3C for right way (no gap) and wrong way (gap) to attach pilasters.

Fig. 3A

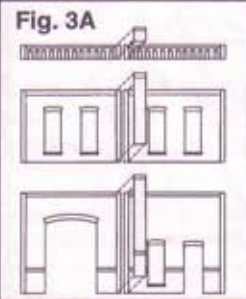

Fig. 3B

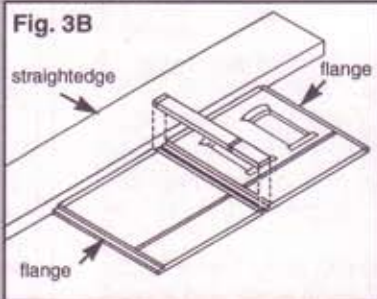
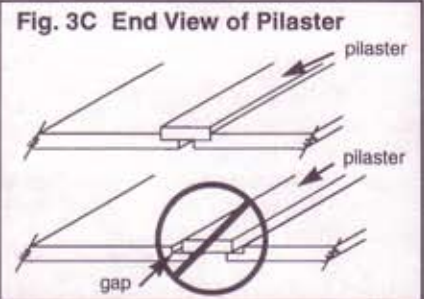

Fig. 3C End View of Pilaster



4 Glue pilasters on ends of each wall panel.

WARNING: Correct placement of wide and narrow pilasters is critical to proper assembly of finished walls.

Wide pilasters must go on ends of front and back walls 1, 3 & 5.

Narrow pilasters must go on ends of side walls 2, 4 & 6. NOTE: Smooth edges on narrow pilasters face toward outside edges, not toward wall sections (Fig. 4B).

Remove flanges on left side of cornice on wall 3 and on right side of cornice above the dock section of building on wall 5 (Fig. 4C).

Fig. 4A

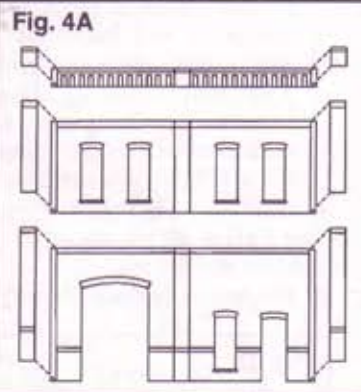

Fig. 4B

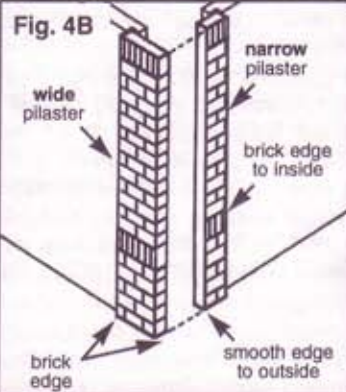
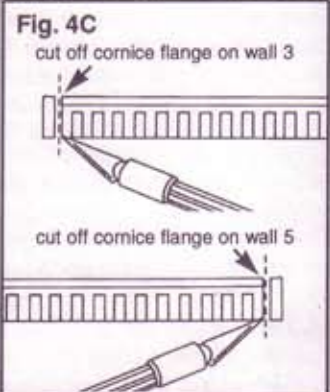

Fig. 4C



5 Step 5 only applies to wall 2, edge C.

Remove inside corner strip from sprue (Fig. 5B).

Cut corner strip so it extends slightly beyond top and bottom of wall (Fig. 5C). These protrusions will be sanded off in Step 6.

Glue corner strip to flange (Fig. 5C).

Using a squaring block as shown in Step 8A, sand flange to remove excess plastic until flange is flush with attached corner strip. (Fig. 5D).

Fig. 5A Wall 2

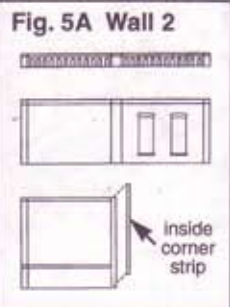

Fig. 5B



Fig. 5C

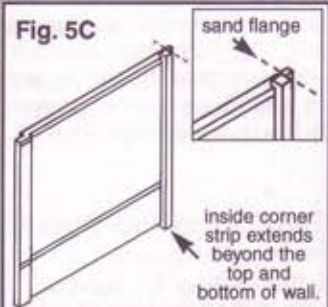

Fig. 5D



6 Sand top and bottom of each assembled wall panel to align and square up all wall section edges.

NOTE: This step is essential to achieve proper fit later (Fig. 6A).

Tack 100 grit sandpaper to flat surface. Make sanding area longer than longest wall.

Use squaring block to hold panels square as you sand edges flat (Fig. 6B).

Do not sand into details.

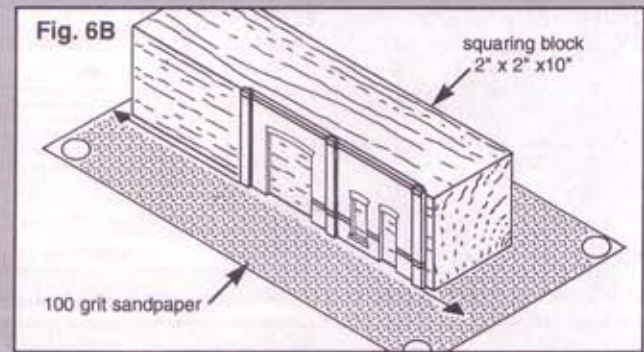
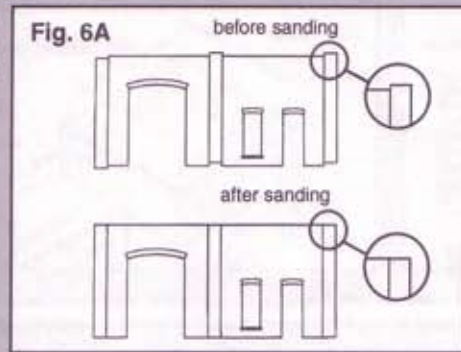

7 Glue wall panels together vertically to form entire wall.

Align pilasters (Fig. 7A) and glue wall panels together.

Align pilasters and glue cornice panel to top wall panel (Fig. 7B).

Entire wall is now assembled (Fig. 7C).

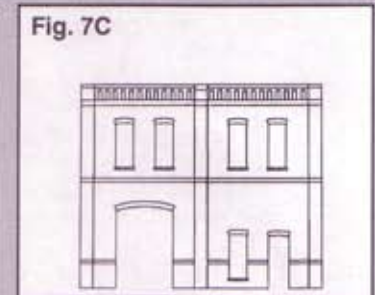
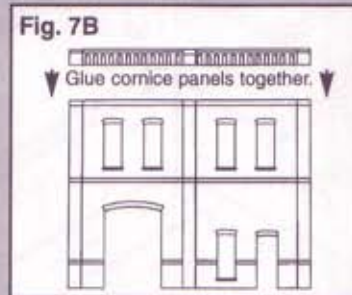
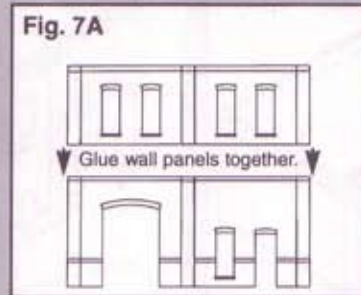

8 Step 8 only applies to walls 2, 4 & 6.

Sand smooth edges of narrow pilasters just enough to square edges (Fig. 8B) so that the pilasters can be aligned to fit snugly with wide pilasters in Step 9.

NOTE: Do not sand edges of wide pilasters (located on front and back walls 1, 3 & 5). To do so would remove brick detail.

Repeat Steps 3-8 for remaining walls until all walls are completed.

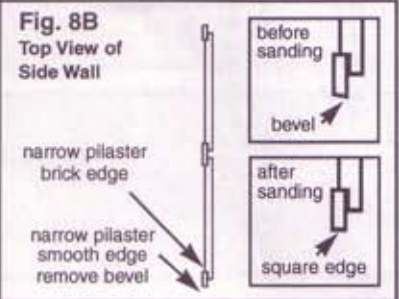
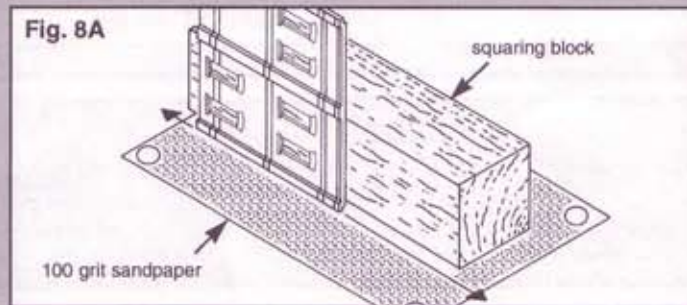

9 After all of the walls are assembled, glue pilasters together at corners.

Use a squaring block to hold corners square while gluing (Fig. 9A).

Join inside corner walls (walls 2 & 3) together at installed corner strip (Fig. 9B).

Butt narrow pilasters (on side walls 2, 4 & 6) against back of wide pilasters (on front and back walls 1, 3 & 5) (Figs. 9A & 9B).

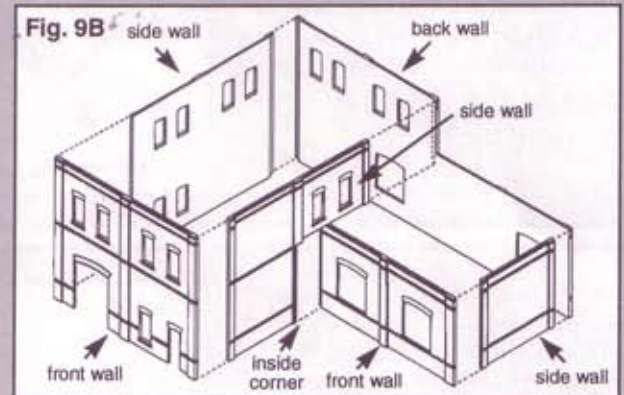
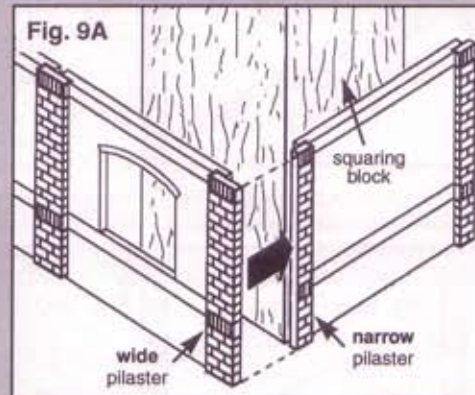

10 Trace inside of roof openings on roof material and cut out roof pieces.

Turn building upside down to trace (Fig. 10A), beginning with larger opening being placed on two edges of roof material.

Make dock area's roof slightly longer than opening to fit under upper single story wall (Fig. 10B).

Cut roofs out, test fit and adjust.

Set roofs aside for now.

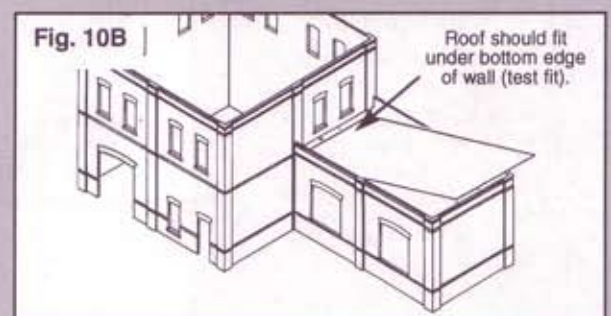
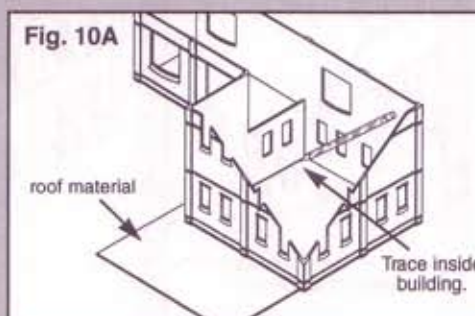

11 Fit and glue parapet trim strips.

Cut, fit and sand parapet trim strips to length to fit building (Fig. 11B).

Glue in place to inside of wall and flush with top edge (Fig. 11C).

Optional: Fill voids at top of wall sections with spackle or plastic putty. Note that you will need to paint building if you follow this step.

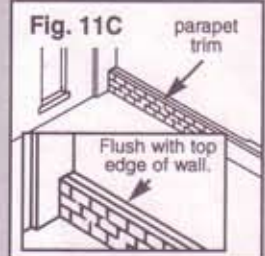
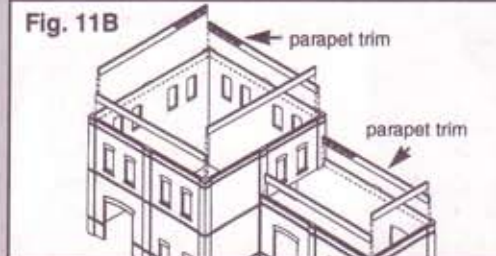
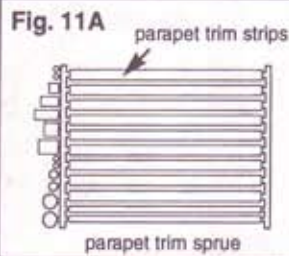

12 Assemble loading dock walls and fit dock floor.

Assemble dock walls in the same manner as cornice panels, noting location of wide and narrow pilasters.

Note that building serves as one side wall and back wall of dock.

Dock floor should overlap dock walls slightly and cover tops of dock pilasters.

Cut dock wall 2 so that it is slightly narrower than the width of dock floor (1 1/2"). (Fig. 12A).

Glue dock walls to building (Fig. 12A).

Using hobby knife cut dock floor to correct length (slightly overlapping dock wall 2). Notch to fit around building's pilasters (Fig. 12B).

Do not glue dock floor in place yet.

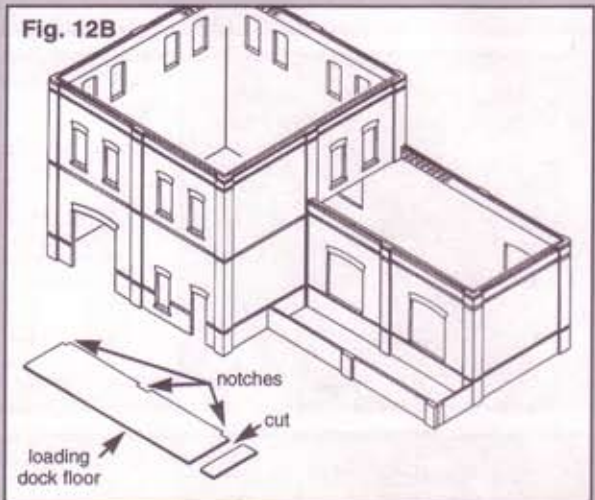
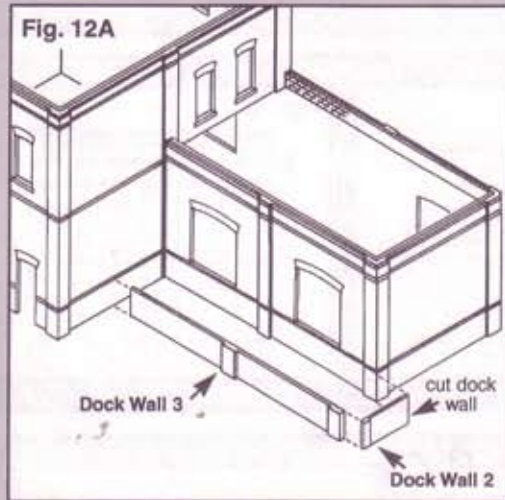

Paint building parts.

We recommend that you paint all building parts for the most realistic appearance. However it is not mandatory.

See *Painting* under *Finishing Touches* for helpful hints.

Doors and windows are easier to paint if left on sprues. When paint is dry, remove windows and doors from sprues. Clean paint from surfaces to be glued. Touch up paint if needed.

13 Install roofs and dock floor.

Position roofs from inside of building. Glue roofs to bottom of parapet trim (Fig. 13A).

Glue dock floor to dock walls (Fig. 13B).

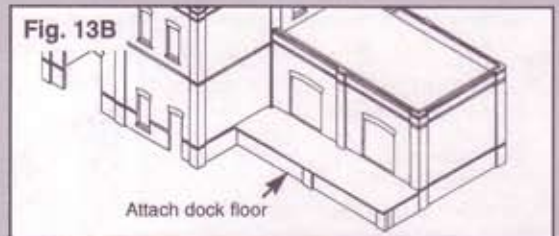
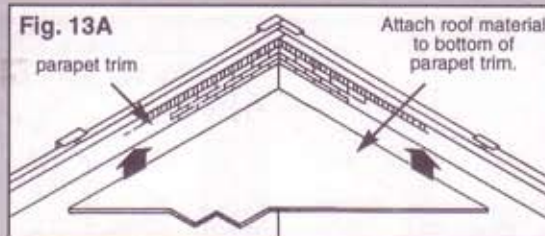

14 Glue window frames and doors with windows to clear window material. Install all doors and windows.

When gluing frames to clear material, leave about 1/4" between each frame (Fig. 14A).

Keep glue off detail and window material that will be seen from the outside of building.

When glue is dry, cut windows and doors apart.

Install windows, doors and freight doors from inside of building (Fig. 14B).

To complete the illusion that building is occupied, place black paper (included in kit) diagonally from corner to corner inside two-story section of building to block light (Fig. 14C).

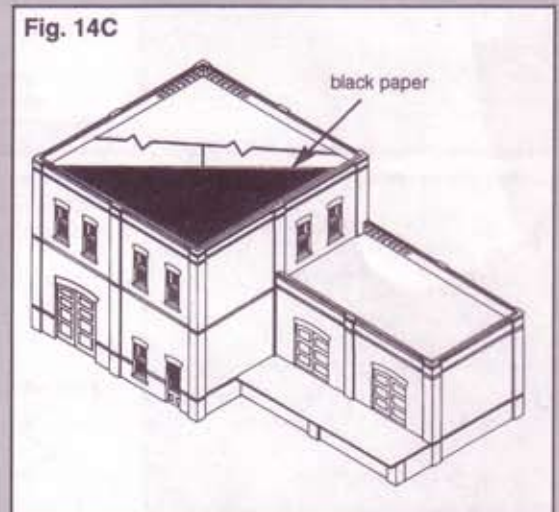
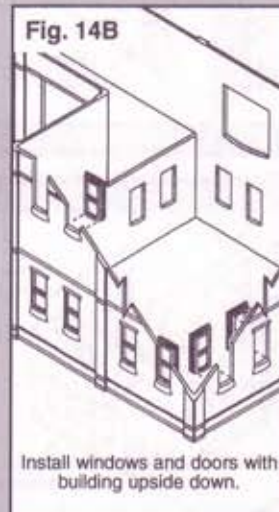
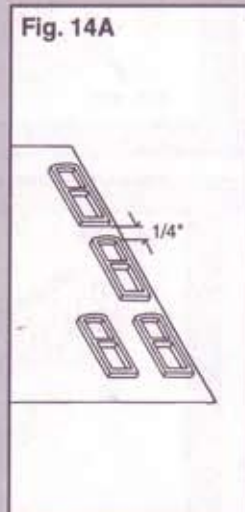

ASSEMBLING DETAILS

Building & Tank Detail Parts Included in Kit

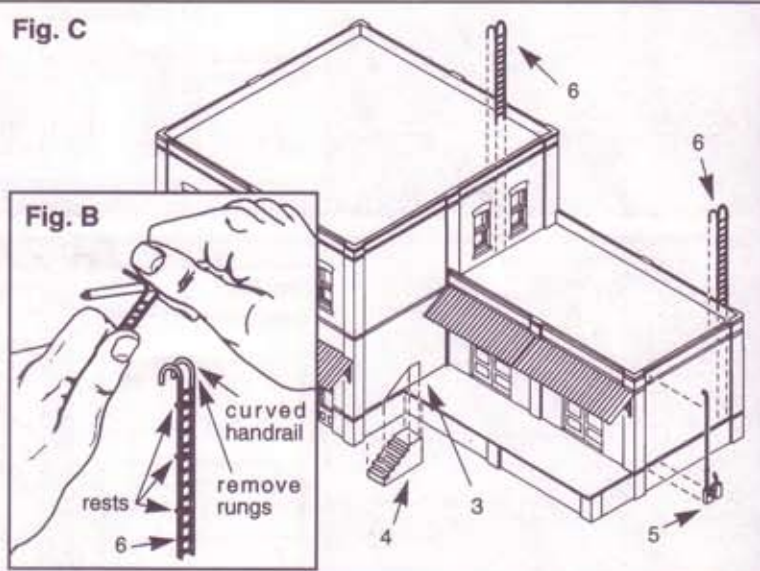
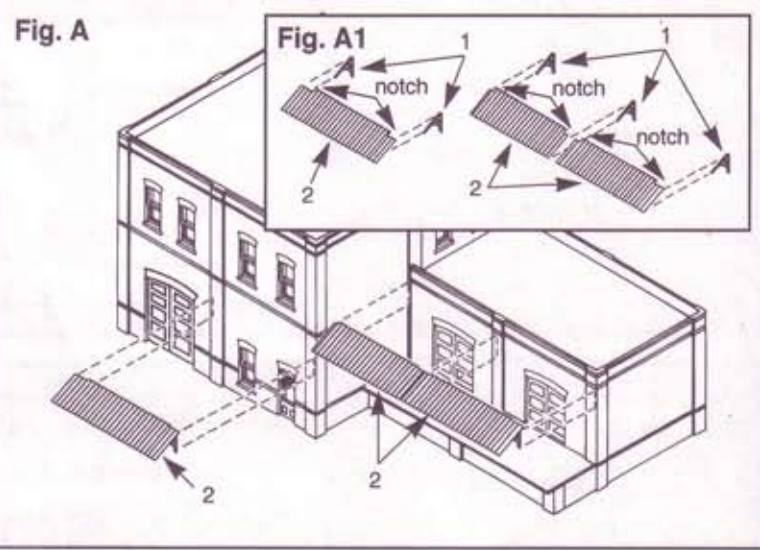
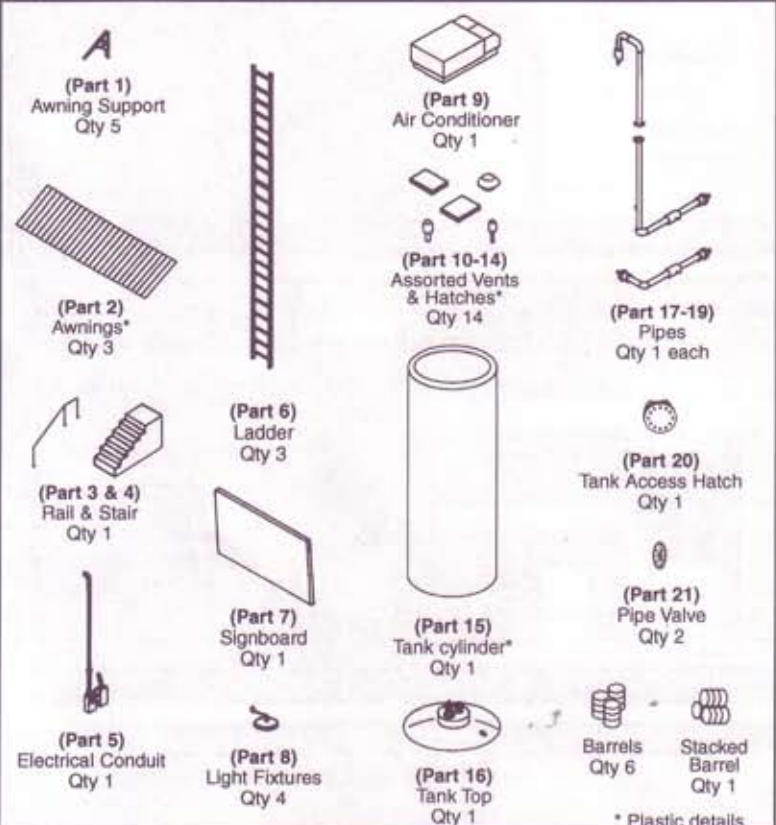

object with a similar diameter (1/8"). **IMPORTANT:** Be sure to keep rails parallel.

2. After bending, carefully remove top three rungs only from this section to form handrails. If necessary, gently sand or file spots where rungs were attached.

3. Shorten ladder as necessary for appearance and/or height of structure by cutting with diagonal cutters. Ladders are attached to walls or a tank by gluing rests and ends of handrails to the structure (Figs. C & G). Do not glue ladders at this time.

C. Glue Part 3 to Part 4. Install Parts 4 -6 on building (Fig. C). **NOTE:** One Part 6 will be placed on tank later. Do not install Part 6 on tank cylinder at this time.

D. Prepare signboard (Part 7):

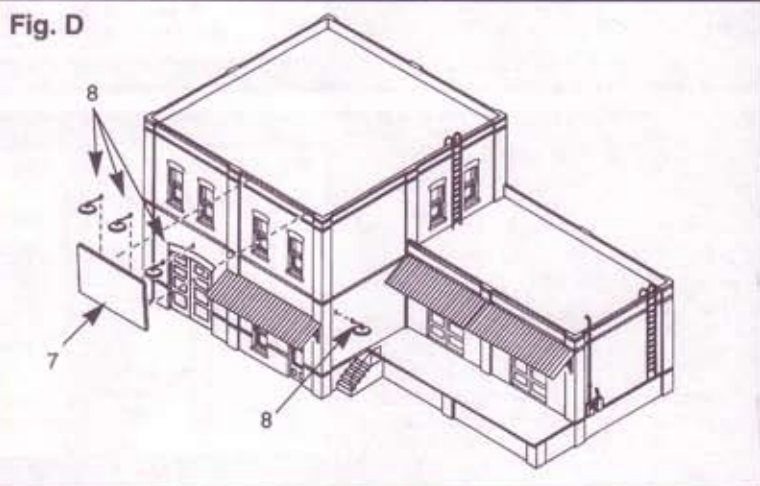

I. PREPARE WHITE METAL CASTINGS:

A. Remove all castings from sprues. (Note: Your kit may contain extra castings due to the molding process.) The castings in this kit will have some parting lines, flash and stems that should be removed. They can be scraped off with a hobby knife, filed off, sanded or cut off with diagonal cutters (i.e., Fiskars).

If castings don't align properly, fit them by removing metal with a hobby knife or file as needed. The metal castings will bend easily and should be handled carefully. If castings are bent or warped, straighten by laying them on flat table and pushing down to table top.

B. So that paint and glue will adhere to metal castings, they must be washed in soapy water to remove residue caused by the molding process. Rinse and allow parts to dry.

C. Plan ahead; it is often easier to prepaint certain castings before assembly. As you read through the instructions, you may decide to paint some parts after fitting them but before gluing. If so, read PAINTING under FINISHING TOUCHES. If you do prepaint, scrape paint from glue points before gluing and touch up paint if necessary after assembly.

D. Castings can be glued together with a fast setting epoxy, or a cyanoacrylate glue such as "super glue." (We prefer a gap-filling, thick cyanoacrylate.)

II. ASSEMBLY:

A. Prepare awnings (Part 2):

- Each of the three corrugated awning pieces (styrene plastic with alternating ridges and grooves) measure 1" x 2 3/4". Use one Part 2 over front door and two Part 2's butted together over dock (Fig. A).
- Begin with one Part 2 that will fit on wall closest to inside corner of dock. Use X-Acto hobby knife to notch one side of this Part 2 to fit around pilasters and corner strip (Fig. A1). Notch another Part 2 to fit around remaining pilasters on dock wall. Notch yet another Part 2 to fit around pilasters on front wall above main entrance. Glue the five awning supports (Part 1) to the three awnings (Part 2). Glue the Part 1's to building (Fig. A).

B. Prepare ladders (Part 6):

- NOTE:** Curved handrails on (Part 6) are optional. If you do not want curved handrails, skip steps 1 & 2.
- To form curved handrails on Part 6 (Fig. B), bend top 3/8" or 1/2" around a piece of coat hanger, sixteen-penny nail or other round

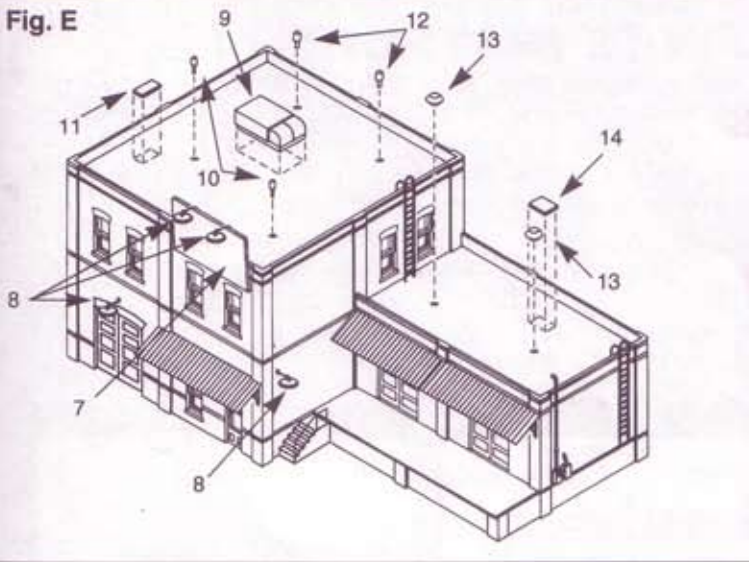
Fig. E

1. Paint Part 7 before applying Dry Transfer. See PAINTING section under FINISHING TOUCHES.

2. Apply Dry Transfer to front of Part 7. See DRY TRANSFERS section under FINISHING TOUCHES.

3. Glue two lights (Part 8) to Part 7 (Fig. D).

E. Glue Parts 7-14 to building (Figs. D & E).

F. Assemble tank and pipes:

1. Sand both ends of tank cylinder (Part 15) to square up and smooth it, if necessary. Lightly sand entire outside surface of Part 15 to help paint adhere.

2. Glue Part 16 to Part 15 (Fig. F).

3. Glue Part 17 to Part 18 (Fig. F). Note: See Figs. J & K for proper alignment.

4. Fit pin on pipe assembly (Parts 17 & 18) to hole on top of Part 16 and glue in place (Fig. G).

5. Align end of Part 19 with Part 18 (Fig. J). End of Part 19 has a pin (Figs. G & I) that you can remove with diagonal cutters or you can drill a 3/32" hole in Part 15, insert pin and glue. If you removed pin, glue Part 19 directly to Part 15.

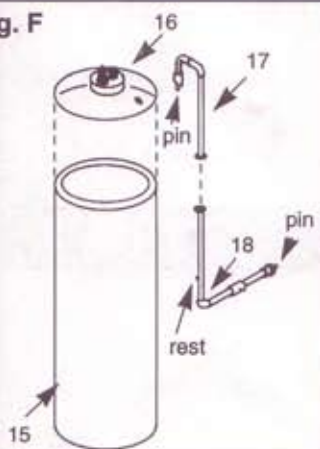
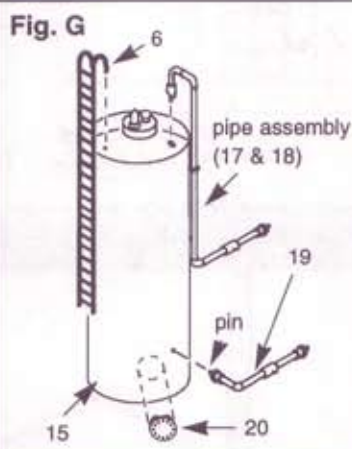
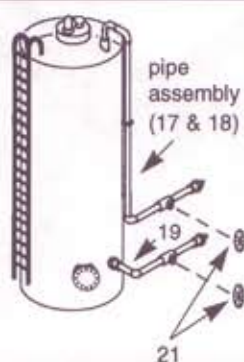
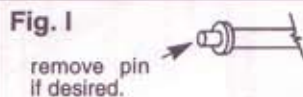
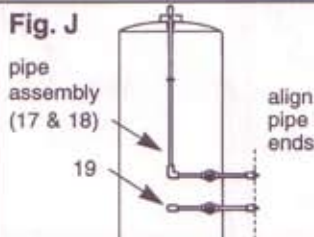
Fig. F**Fig. G****Fig. H****Fig. I****Fig. J**

G. Part 20 is concave to fit tightly to Part 15 (Fig. G); do not attempt to flatten it. Glue Part 20 to Part 15 (Fig. G).

H. Glue one Part 21 to standoff pin on Part 18 (Fig. H). Repeat on Part 19.

I. Decide the location for the Drywell Inks Dry Transfer logo and apply on Part 15 before attaching a ladder (Part 6) to assembled tank. Follow instructions in the DRY TRANSFERS section under FINISHING TOUCHES to apply logo.

J. Place Part 15 next to building in location shown in Fig. K. Note: Ends of Parts 18 and 19 have pins. You may remove pins with diagonal cutter or you may drill two 3/32" holes in building, insert Parts 18 & 19, and glue. If you remove pins, glue Parts 18 and 19 directly to building.

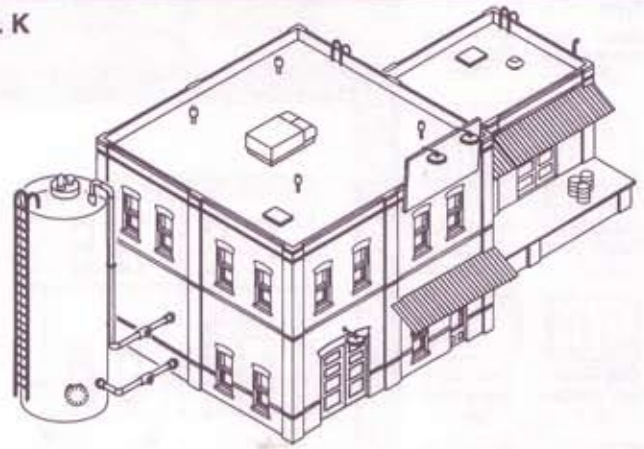
Fig. K

III. FINISHING TOUCHES:

PAINTING

Appearance of building and castings is enhanced by painting. Use of a primer is recommended before painting castings. We recommend airbrushing with solvent-based enamel paints such as Floquil in a flat finish. Use water soluble paint such as Polly 'S' in a flat finish for brushing. Color is your choice. We prefer natural brick colors in earth tones for entire building and the dock walls. Other suggestions include: Dock floor - Floquil "Concrete," Roof - flat black. Color of windows and doors may match or contrast with building. Building may be aged with chalks or lightly misted by airbrushing with thinned flat black paint. Small details may be painted a contrasting color which will add realism and enhance building's appearance. See the picture on the box for ideas on painting building and details.

OPTIONAL IDEAS

Masking tape placed on inside surface of windows at various heights from top of the windows simulates window shades and gives the building an occupied appearance.

You may want to apply a very fine sand to the roofs to simulate a "gravel" texture.

DRY TRANSFERS

A. Position decal in position shown in picture on front of package, or where desired.

B. Hold carrier sheet firmly so it can't move while you rub over the decal with a burnisher or soft leaded, dull pencil.

C. Carefully lift carrier sheet from one end while holding it in place. If transfer was incomplete, let sheet fall back into place and transfer remainder.

D. Place backing paper over decal and reburnish.

Suggestion: Place the small Drywell Inks decal on the company truck (not furnished).

NOTE: The cast details and Dry Transfers in this kit were made by Woodland Scenics exclusively for Design Preservation Models. See the entire line of Woodland Scenics Dry Transfers and castings at your favorite hobby store.

Design Preservation Models

P.O. Box 66
Linn Creek, MO 65052